

version 1.0



2023-2024 Catalogue

Electrophoresis and related products



Innovative Life Sciences Tools

Mini Horizontal Gel Electrophoresis System

MJ-105A MT-108

For MJ-105A

The MJ-105A horizontal electrophoresis system offers many advantages for nucleic acid separation. Agarose gels are convenient to cast and samples are easy to load with this recognizable mini horizontal cell. Its molded design prevents cracks and leakages and the sturdy PC provides a 130°C temperature capacity. The safety interlock cover is designed to prevent electrical hazards during electrophoresis. It is ideal for several applications, including Northern and Southern blotting, Cosmid library restriction analysis, STS screening, microsatellite analysis, PCR fragment analysis, RFLP analysis, DNA finger-printing and high throughput analysis.

For MT-108

MT-108 horizontal electrophoresis units offer many advantages for nucleic acid separation. Agarose gels are easy to cast and samples are easy to load. MT-108's longer tray allows running of bigger fragments to attain higher resolution. Its molded design prevents cracks or leakages, and its sturdy PC provides a temperature capacity of up to 130°C. A safety interlocking cover is designed to prevent electrical hazards during electrophoresis runs. It is ideal for many applications, including Northern and Southern blotting, Cosmid library restriction analysis, STS screening, Microsatellite analysis, PCR fragment analysis, RFLP analysis, DNA fingerprinting and high-throughput analysis.



MJ-105A

MJ-105A is offered as a complete system for the user to cast, and run electrophoresis. including:

- 1 x Transparent tank and transparent lid
- 2 x MJ-G01 (Gel Maker Stand)
- 2 x MJ-T02 (107x60mm Tray)
- 4 x MJ-T01 (52x60mm Tray)
- 1 x MJ-C01 (Double side comb: 8 teeth x 2 & 17 teeth; 12 teeth x 2 & 25 teeth)
- 1 x MT-C03 (Multiple pipette compatible 23 teeth, Prep 1 & Marker 2, Prep 2 & Marker 2; 6 teeth x 2 for mini gel & 12 teeth for midi gel)
- 1 x Black & red electrophoresis cable



Multichannel pipette compatible

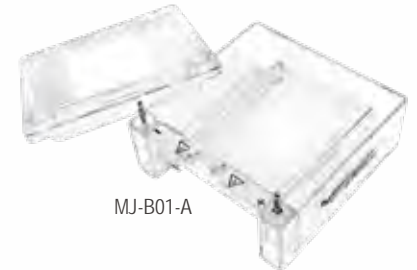

MJ-B01-A



Features

- Less agarose consumption
- Less running buffer consumption
- Multichannel pipette-compatible
- Single molded tank
- Safety & Ventilation lid
- High temperature capability, 130°C
- Easy sample loading
- Great indications for gel making and running
- No tapes, clamps or springs needed for gel casting
- No direct heat impact from power supply unit

For MJ-105A additional features

- Transparent tank and lid
- Real time observation with MBE-300
- Contains 2 sets of gel maker stand
- Cast 6 pcs of agarose gel in one time

For MT-108 additional features

- Two tray options available
- Cast 3 pcs of agarose gel in one time



MT-108

MT-108 is offered as a complete system for the user to cast, and run electrophoresis. including:

- 1 x Snow tank and transparent lid
- 1 x MT-G01 (Gel Maker Stand)
- 1 x MT-T01 (105x83mm Tray)
- 2 x MT-T02 (50x83mm Tray)
- 1 x MJ-C01 (Double side comb: 8 teeth x 2 & 17 teeth; 12 teeth x 2 & 25 teeth)
- 1 x MT-C03 (Multiple pipette compatible 23 teeth, Prep 1 & Marker 2, Prep 2 & Marker 2; 6 teeth x 2 for mini gel & 12 teeth for midi gel)
- 1 x Black & red electrophoresis cable

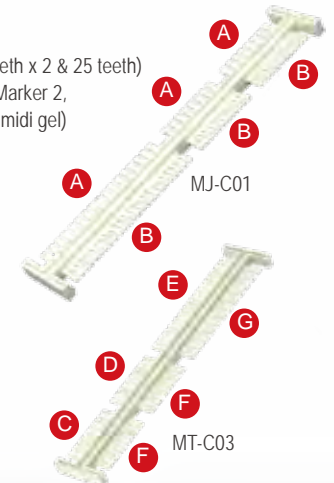
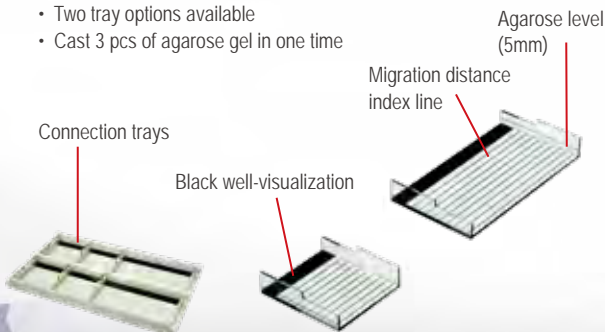

	Cat. No.	Tooth Thickness	Tooth Width	Sample Volume for a 5mm thick gel (ul)
A	MJ-C01	1.0mm	4.0mm	20
B	MJ-C01	1.5mm	2.8mm	21
C	MT-C03	1.0mm	36.0mm	180
D	MT-C03	1.0mm	17.0mm	85
E	MT-C03	1.0mm	3.0mm	15
F	MT-C03	1.0mm	6.0mm	30
G	MT-C03	1.0mm	6.5mm	32.5

Specification

Cat. No	MJ-105A	MT-108
Appearance	Transparent tank & transparent lid	Snow tank & transparent lid
Material	PC (Polycarbonate)	
Lid Material	PC (Polycarbonate)	AS (Acrylonitrile-Styrene Copolymer)
Temperature Capacity	130°C	
Transparent Lid	Safety ventilation design	
Gel Dimension (WxL)	4.2"x2.4" (107x60mm)	4.1"x3.3" (105x83mm)
	2.1"x2.4" (52x60mm)	2"x3.3" (50x83mm)
Tray	Black well-visualization strip	
	Migration distance index line	
	Agarose level, 0.2" (5mm)	
Rapid Casting Gel	Use gel maker stand	
Maximum Gel Thickness	0.39" (10mm)	
Maximum Sample	25 samples	
Buffer Volume	0.05gal (200ml)	0.11gal (400ml)
Operating Temperature	4 - 40°C	
Dimension (WxLxH)	5.8"x5.7"x2.3" (148.3x145.8x59.1mm)	5.4"x7.4"x2.3" (136x188x58mm)
Weight	Approx. 1.1lb (0.5kg)	Approx. 1.5lb (0.7kg)

Accessories

Cat. No	Product Description
MJ-105A Accessories	
MJ-B01-A	Transparent tank and lid, without accessories
MJ-LID-AM580	580nm amber filter lid with fan, suitable for MJ-105A
MBE-LID-AM580	An inclined 580nm amber filter, suitable for MBE-200 and MBE-300
MJ-G01	Gel maker stand
MJ-T01	52x60mm Tray
MJ-T02	107x60mm Tray
MJ-C01	Analytical comb (8 teeth x 2 for mini gel & 17 teeth for midi gel (thickness: 1.0mm), 12 teeth x 2 for mini gel & 25 teeth for midi gel (thickness: 1.5mm))
MT-C03	Analytical comb 1.0mm-thick (multiple pipette compatible 23 teeth, Prep 1 & Maker 2, Prep 2 & Maker 2 on one side; 6 teeth x 2 for mini gel & 12 teeth for midi gel on the other side)
MBE-150-CABLE	Threaded Black and Red Electrophoresis Cable
MJ-CASTER-C	2 x MJ-G01; 4 x MJ-T01; 2 x MJ-T02; 1 x MJ-C01 and 1 x MT-C03
MBE-HOOD	Synthetic paper hood
MT-108 Accessories	
MT-B01	Wide Mini Tank and lid, without accessories
MT-G01	Gel maker stand
MT-T01	105x83mm Tray
MT-T02	50x83mm Tray
MJ-C01	Analytical Comb (8 teeth x 2 for mini gel & 17 teeth for midi gel (thick: 1.0mm), 12 teeth x 2 for midi gel & 25 teeth for midi gel (thick: 1.5mm))
MT-C03	Analytical Comb 1.0mm-thick (multiple pipette compatible 23 teeth, Prep 1 & Maker 2, Prep 2 & Maker 2 on one side; 6 teeth x 2 for mini gel & 12 teeth for midi gel on the other side)
MT-P01	Electrophoresis Cable (black and red) for MT-108 only
MT-CASTER-C	1 x MT-G01; 1 x MT-T01; 2 x MT-T02; 1 x MJ-C01 and 1 x MT-C03



Ordering Information

Cat. No	Product Description
MJ-105A	Transparent Mini Horizontal Electrophoresis System
MT-108	Wide Mini Horizontal Electrophoresis System



* All images are for reference only, actual products might differ from the pictures above.
* Technical specifications subject to change without notice.

Midi plus / plus-1 / plus-2 Horizontal Electrophoresis System

ME7-7-10
ME10-7-10
ME15-7-10-15

Our Midi series have been designed for routine horizontal gel electrophoresis with wide degrees of versatility. All of our gel tanks are made from injection molded construction for durable and leak proof environment. Varieties of special combs are available to maximize your sample size.

Midi plus includes the 70x70 and 70x100mm gel trays for a maximum of 64 samples, designed for low to medium numbers of samples.

Midi plus-1 includes 100x70 and 100x100mm gel tray to allow 100 samples per gel to be resolved. Ideal for those routinely check medium numbers of samples over short to medium gel run lengths.

The Midi plus-2 system provides three sizes of trays to maximize your sample size, 150x70, 150x100, 150x150mm. Midi plus-2 allows up to 210 samples per run per gel.

Easy click lid removal

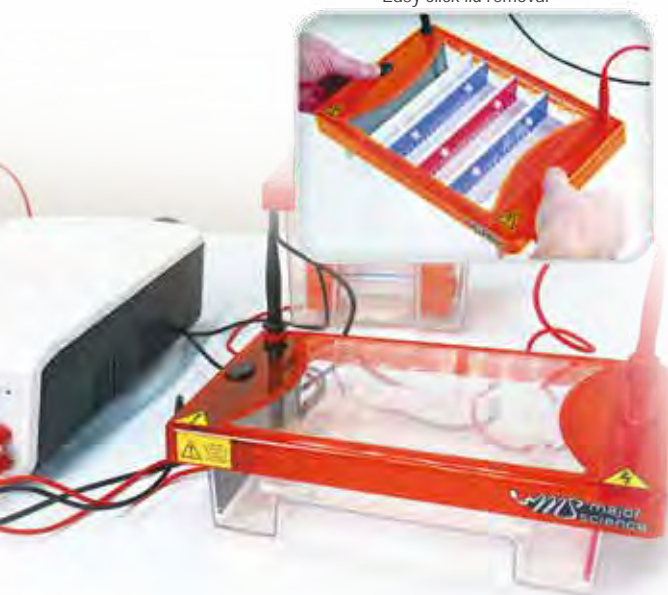

Features

- Low buffer consumption
- Single molded tank
- Two tray options available (ME7-7-10, ME10-7-10)
- Three tray options available (ME15-7-10-15)
- Easy sample loading
- Multi-channel pipette compatible
- Great indications for gel making and running
- No tape, clamps or springs needed



ME7-7-10

CE

ME7-7-10 is offered as a complete system for the user to cast, and run electrophoresis. including:

- 1 x Electrophoresis tank & lid
- 1 x ME7-UV7 (70x70mm UV tray)
- 1 x ME7-UV10 (70x100mm UV tray)
- 2 x ME7-8-1 (8 sample combs, 1mm thick)
- 1 x ME7-UVDAM (UV tray dams, 2pcs)
- 1 x ME7-LG (Loading guides (Set))
- 1 x Black & red electrophoresis cable



ME10-7-10

CE

ME10-7-10 is offered as a complete system for the user to cast, and run electrophoresis. including:

- 1 x Electrophoresis tank & lid
- 1 x ME10-UV7 (100x70mm UV tray)
- 1 x ME10-UV10 (100x100mm UV tray)
- 2 x ME10-16-1 (16 sample combs, 1mm thick)
- 1 x ME10-UVDAM (UV tray dams, 2pcs)
- 1 x ME10-LG (Loading guides (Set))
- 1 x Black & red electrophoresis cable



ME15-7-10-15

CE

ME15-7-10-15 is offered as a complete system for the user to cast, and run electrophoresis. including:

- 1 x Electrophoresis tank & lid
- 1 x ME15-UV7 (150x70mm UV tray)
- 1 x ME15-UV10 (150x100mm UV tray)
- 1 x ME15-UV15 (150x150mm UV tray)
- 2 x ME15-20-1 (20 sample combs, 1mm thick)
- 1 x ME15-UVDAM (UV tray dams, 2pcs)
- 1 x ME15-LG (Loading guides (Set))
- 1 x Black & red electrophoresis cable

Specification

Cat. No.	ME7-7-10	ME10-7-10	ME15-7-10-15
Dimension (WxLxH)	8.3"x3.5"x3.5" (210x90x90mm)	8.7"x4.9"x3.5" (220x125x90mm)	10.4"x6.9"x3.5" (265x175x90mm)
Gel Dimension (WxL)	2.8"x2.8" (70x70mm) 2.8"x3.9" (70x100mm)	3.9"x2.8" (100x70mm) 3.9"x3.9" (100x100mm)	5.9"x2.8" (150x70mm) 5.9"x3.9" (150x100mm) 5.9"x5.9" (150x150mm)
Maximum Sample	32 for 2.8"x2.8" (70x70mm) Tray (2x16 sample combs)	50 for 3.9"x2.8" (100x70mm) Tray (2x25 sample combs)	70 for 5.9"x2.8" (150x70mm) Tray (2x35 sample combs)
	64 for 2.8"x3.9" (70x100mm)Tray (4x16 sample combs)	100 for 3.9"x3.9" (100x100mm) Tray (4x25 sample combs)	140 for 5.9"x3.9" (150x100mm) Tray (4x35 sample combs)
			210 for 5.9"x5.9" (150x150mm) Tray (6x35 sample combs)
Buffer Volume	0.06gal (225ml)	0.08gal (300ml)	0.13gal (500ml)
Construction	Injection molded construction		
	Durable, leak proof environment for complete safety and long life		
Cassette Type Electrode	Inexpensive, easy to replace		
	Made of 99.99% corrosion resistant pure platinum		
Electrical Safety	Lid can only be fastened in one way		
	Upon lid removal, power is disconnected from buffer chamber		
Rapid Casting Gel	Use casting dams		

Ordering Information

Cat. No.	Product Description
ME7-7-10	Midi plus, 70x70mm & 70x100mm UV tray, 2x8 sample 1mm thick combs, loading guides and dams
ME7-UV7	Midi plus, 70x70mm UV tray
ME7-UV10	Midi plus, 70x100mm UV tray
ME7-UVS	70mm UV gel scoop
ME7-UVDAM	Midi plus, UV tray dams (2 pcs)
ME7-LG	Loading Guides
ME7LID	Midi plus lid (No cables)
ME7TANK	Midi plus Tank (including electrodes)
ME7-BSB	Buffer Saver Blocks for Midi plus, package of 2
ME10-7-10	Midi plus-1, 100x70mm & 100x100mm UV tray, 2x16 sample 1mm thick combs, loading guides and dams
ME10-UV7	Midi plus-1, 100x70mm UV tray
ME10-UV10	Midi plus-1, 100x100mm UV tray
ME10-UVS	100mm UV gel scoop
ME10-UVDAM	Midi plus-1, UV tray dams (2 pcs)
ME10-LG	Loading Guides for Midi Plus-1
ME10LID	Midi plus-1 lid (No cables)
ME10TANK	Midi plus-1 Tank (including electrodes)
ME10-BSB	Midi plus-1 buffer saving block, save up to 100ml, 2/pk
ME7/10-FC	Midi plus/Midi plus-1, Flexicaster
ME15-7-10-15	Midi plus-2, 150x70, 100 & 150mm UV tray, 2x20 sample 1mm thick combs, loading guides and dams
ME15-UV7	Midi plus-2, 150x70mm UV tray
ME15-UV10	Midi plus-2, 150x100mm UV tray
ME15-UV15	Midi plus-2, 150x150mm UV tray
ME15/20-FC	Midi plus-2/Maxi, Flexicaster
ME15-UVS	150mm UV gel scoop
ME15-UVDAM	Midi plus-2, UV tray dams (2 pcs)
ME15-LG	Loading Guides for Midi plus-2
ME15LID	Midi plus-2, lid (No cables)
ME15TANK	Midi plus-2 Tank (including electrodes)
ME15-BSB	Midi plus-2, saver blocks, pk/2



Casting dams allow gels to be rapidly cast

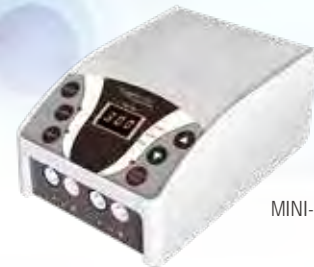

MINI-300

Recommended economic power supply

For ME7-7-10

Cat. No.	Comb Description	Sample Volume
ME7-1-0.75	Prep 1, Marker 1, 0.75mm thick	152ul
ME7-2-0.75	Prep 2, Marker 2, 0.75mm thick	68ul
ME7-4-0.75	Prep 4, Marker 2, 0.75mm thick	36ul
ME7-8MC-0.75	8 sample MC, 0.75mm thick	8ul
ME7-8-0.75	8 sample, 0.75mm thick	19ul
ME7-10-0.75	10 sample, 0.75mm thick	14ul
ME7-12MC-0.75	12 sample MC, 0.75mm thick	10ul
ME7-16-0.75	16 sample, 0.75mm thick	7ul

Cat. No.	Comb Description	Sample Volume
ME7-1-1.5	Prep 1, Marker 1, 1.5mm thick	304ul
ME7-2-1.5	Prep 2, Marker 2, 1.5mm thick	135ul
ME7-4-1.5	Prep 4, Marker 2, 1.5mm thick	72ul
ME7-8MC-1.5	8 sample MC, 1.5mm thick	17ul
ME7-8-1.5	8 sample, 1.5mm thick	37ul
ME7-10-1.5	10 sample, 1.5mm thick	27ul
ME7-12MC-1.5	12 sample MC, 1.5mm thick	20ul
ME7-16-1.5	16 sample, 1.5mm thick	15ul

ME7-1-1	Prep 1, Marker 1, 1mm thick	203ul
ME7-2-1	Prep 2, Marker 2, 1mm thick	90ul
ME7-4-1	Prep 4, Marker 2, 1mm thick	48ul
ME7-8MC-1	8 sample MC, 1mm thick	11ul
ME7-8-1	8 sample, 1mm thick	25ul
ME7-10-1	10 sample, 1mm thick	18ul
ME7-12MC-1	12 sample MC, 1mm thick	14ul
ME7-16-1	16 sample, 1mm thick	10ul

ME7-1-2	Prep 1, Marker 1, 2mm thick	405ul
ME7-2-2	Prep 2, Marker 2, 2mm thick	180ul
ME7-4-2	Prep 4, Marker 2, 2mm thick	96ul
ME7-8MC-2	8 sample MC, 2mm thick	23ul
ME7-8-2	8 sample, 2mm thick	50ul
ME7-10-2	10 sample, 2mm thick	36ul
ME7-12MC-2	12 sample MC, 2mm thick	27ul
ME7-16-2	16 sample, 2mm thick	20ul



Fast fix slot electrodes, no need rewiring



Complete package offers as standard

For ME10-7-10

Cat. No.	Comb Description	Sample Volume
ME10-1-0.75	Prep 1, Marker 1, 0.75mm thick	270ul
ME10-2-0.75	Prep 2, Marker 2, 0.75mm thick	118ul
ME10-4-0.75	Prep 4, Marker 2, 0.75mm thick	57ul
ME10-8-0.75	8 sample, 0.75mm thick	30ul
ME10-10MC-0.75	10 sample MC, 0.75mm thick	20ul
ME10-12-0.75	12 sample, 0.75mm thick	17ul
ME10-16-0.75	16 sample, 0.75mm thick	12ul
ME10-20MC-0.75	20 sample MC, 0.75mm thick	10ul
ME10-25-0.75	25 sample, 0.75mm thick	7ul

Cat. No.	Comb Description	Sample Volume
ME10-1-1.5	Prep 1, Marker 1, 1.5mm thick	540ul
ME10-2-1.5	Prep 2, Marker 2, 1.5mm thick	236ul
ME10-4-1.5	Prep 4, Marker 2, 1.5mm thick	115ul
ME10-8-1.5	8 sample, 1.5mm thick	61ul
ME10-10MC-1.5	10 sample MC, 1.5mm thick	41ul
ME10-12-1.5	12 sample, 1.5mm thick	34ul
ME10-16-1.5	16 sample, 1.5mm thick	24ul
ME10-20MC-1.5	20 sample MC, 1.5mm thick	20ul
ME10-25-1.5	25 sample, 1.5mm thick	15ul

ME10-1-1	Prep 1, Marker 1, 1mm thick	360ul
ME10-2-1	Prep 2, Marker 2, 1mm thick	158ul
ME10-4-1	Prep 4, Marker 2, 1mm thick	77ul
ME10-8-1	8 sample, 1mm thick	41ul
ME10-10MC-1	10 sample MC, 1mm thick	27ul
ME10-12-1	12 sample, 1mm thick	23ul
ME10-16-1	16 sample, 1mm thick	16ul
ME10-20MC-1	20 sample MC, 1mm thick	14ul
ME10-25-1	25 sample, 1mm thick	10ul

ME10-1-2	Prep 1, Marker 1, 2mm thick	720ul
ME10-2-2	Prep 2, Marker 2, 2mm thick	315ul
ME10-4-2	Prep 4, Marker 2, 2mm thick	153ul
ME10-8-2	8 sample, 2mm thick	81ul
ME10-10MC-2	10 sample MC, 2mm thick	54ul
ME10-12-2	12 sample, 2mm thick	45ul
ME10-16-2	16 sample, 2mm thick	32ul
ME10-20MC-2	20 sample MC, 2mm thick	27ul
ME10-25-2	25 sample, 2mm thick	20ul

*Sample volume (SV) = sample volume per well, for 5 mm thick gel (ul)

For ME15-7-10-15

Cat. No.	Comb Description	Sample Volume
ME15-1-0.75	Prep 1, Marker 1, 0.75mm thick	371ul
ME15-2-0.75	Prep 2, Marker 2, 0.75mm thick	169ul
ME15-4-0.75	Prep 4, Marker 2, 0.75mm thick	91ul
ME15-10-0.75	10 sample, 0.75mm thick	34ul
ME15-12-0.75	12 sample, 0.75mm thick	30ul
ME15-20-0.75	20 sample, 0.75mm thick	16ul
ME15-35-0.75	35 sample, 0.75mm thick	7ul
ME15-10MC-0.75	10 sample MC, 0.75mm thick	22ul
ME15-14MC-0.75	14 sample MC, 0.75mm thick	22ul
ME15-16MC-0.75	16 sample MC, 0.75mm thick	20ul
ME15-18MC-0.75	18 sample MC, 0.75mm thick	8ul
ME15-28MC-0.75	28 sample MC, 0.75mm thick	8ul
ME15-30MC-0.75	30 sample MC, 0.75mm thick	9ul

ME15-1-1	Prep 1, Marker 1, 1mm thick	495ul
ME15-2-1	Prep 2, Marker 2, 1mm thick	225ul
ME15-4-1	Prep 4, Marker 2, 1mm thick	122ul
ME15-10-1	10 sample, 1mm thick	45ul
ME15-12-1	12 sample, 1mm thick	41ul
ME15-20-1	20 sample, 1mm thick	21ul
ME15-35-1	35 sample, 1mm thick	10ul
ME15-10MC-1	10 sample MC, 1mm thick	29ul
ME15-14MC-1	14 sample MC, 1mm thick	29ul
ME15-16MC-1	16 sample MC, 1mm thick	27ul
ME15-18MC-1	18 sample MC, 1mm thick	11ul
ME15-28MC-1	28 sample MC, 1mm thick	11ul
ME15-30MC-1	30 sample MC, 1mm thick	13ul

Cat. No.	Comb Description	Sample Volume
ME15-1-1.5	Prep 1, Marker 1, 1.5mm thick	743ul
ME15-2-1.5	Prep 2, Marker 2, 1.5mm thick	338ul
ME15-4-1.5	Prep 4, Marker 2, 1.5mm thick	182ul
ME15-10-1.5	10 sample, 1.5mm thick	68ul
ME15-12-1.5	12 sample, 1.5mm thick	61ul
ME15-20-1.5	20 sample, 1.5mm thick	32ul
ME15-35-1.5	35 sample, 1.5mm thick	15ul
ME15-10MC-1.5	10 sample MC, 1.5mm thick	44ul
ME15-14MC-1.5	14 sample MC, 1.5mm thick	44ul
ME15-16MC-1.5	16 sample MC, 1.5mm thick	41ul
ME15-18MC-1.5	18 sample MC, 1.5mm thick	17ul
ME15-28MC-1.5	28 sample MC, 1.5mm thick	17ul
ME15-30MC-1.5	30 sample MC, 1.5mm thick	19ul

ME15-1-2	Prep 1, Marker 1, 2mm thick	990ul
ME15-2-2	Prep 2, Marker 2, 2mm thick	450ul
ME15-4-2	Prep 4, Marker 2, 2mm thick	243ul
ME15-10-2	10 sample, 2mm thick	90ul
ME15-12-2	12 sample, 2mm thick	81ul
ME15-20-2	20 sample, 2mm thick	43ul
ME15-35-2	35 sample, 2mm thick	20ul
ME15-10MC-2	10 sample MC, 2mm thick	59ul
ME15-14MC-2	14 sample MC, 2mm thick	59ul
ME15-16MC-2	16 sample MC, 2mm thick	54ul
ME15-18MC-2	18 sample MC, 2mm thick	23ul
ME15-28MC-2	28 sample MC, 2mm thick	23ul
ME15-30MC-2	30 sample MC, 2mm thick	25ul



Extensive range of combs
 Black: 0.75mm for ultra resolved bands
 White: 1mm supplied as standard
 Red: 1.5mm for large sample volume
 Blue: 2mm for large sample volume

*Sample volume (SV) = Sample volume for 5mm thick gel (ul) per well.



MC = Multi-channel pipette compatible

* All images are for reference only, actual products might differ from the pictures above.
 * Technical specifications subject to change without notice.

Maxi Horizontal Gel Electrophoresis System

ME20 series ME26-16-24-32

For ME20 series

Maxi is primarily designed for resolution of high throughput of samples as in cloning or PCR experiments. Maxi allows ultra high-resolution separations over extended runs. Tray sizes correspond to standard blotter sizes. It also allows for easy sample transfer onto a membrane for further analysis. Three tray sizes are available, 200x200mm, 200x250mm and 200x100mm. Multi-channel pipette compatible combs for up to 40 samples each facilitate speedy loading of up to 440 samples per gel. 50 sample combs (not multi-channel pipette compatible) allow maximum sample capability of 550 samples per gel.

For ME26-16-24-32

Maxi-plus is designed for rapid screening of very large numbers of cloning or PCR samples, and it has the maximum capacity of 672 samples per gel. This allows loading and analysis of exactly seven 96 well format microliter plates. The large gel run length of 320mm also allows resolution of samples over a long distance for separation of complex sample bands such as in restriction fragment analysis. Maxi-plus is available with a full length tray of 260x320mm or with two other tray length options of 260x160mm and 260x240mm so that user's exact requirements can be met. In addition to options for single length gel trays, Maxi-plus is available with all three gel tray lengths to provide the maximum flexibility, versatility and value. Buffer recirculation ports are included as standard to allow enhanced resolution over extended runs, while loading guides enhance visibility for easy sample loading.

Features

- Low buffer consumption
- Multi-channel pipette compatibility
- Great indications for gel making and running
- No tape, clamps or springs needed

For ME20 series additional features

- Up to 450 samples per tray

For ME26-16-24-32 additional features

- Up to 672 samples per tray
- Three tray options available

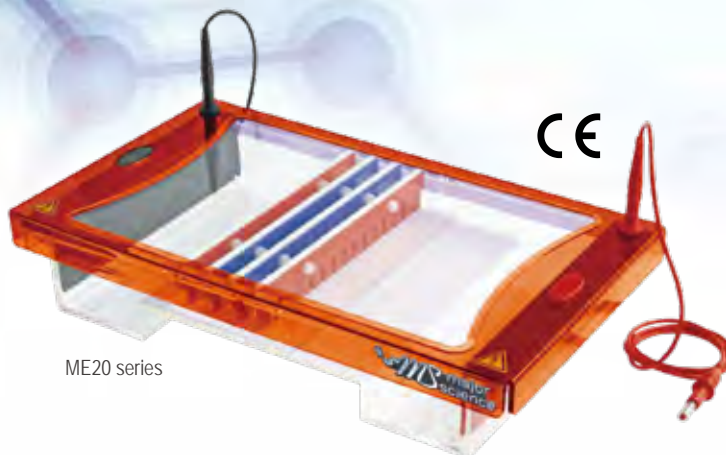

ME20 series

ME20 series is offered as a complete system for the user to cast, and run electrophoresis. including:

- 1 x Electrophoresis tank & lid
- 1 x ME20-UV10 (200x100mm UV tray)
- 1 x ME20-UV20 (200x200mm UV tray)
- 1 x ME20-UV25 (200x250mm UV tray, for ME20-25 only)
- 2 x ME20-20MC-1 (20 sample combs, 1mm thick)
- 1 x ME20-UV DAM (UV tray dams, 2pcs)
- 1 x ME20-LG (Loading guides (Set))
- 1 x Black & red electrophoresis cable



ME26-16-24-32

ME26-16-24-32 is offered as a complete system for the user to cast, and run electrophoresis. including:

- 1 x Electrophoresis tank & lid
- 1 x ME26-UV16 (260x160mm UV tray)
- 1 x ME26-UV24 (260x240mm UV tray)
- 1 x ME26-UV32 (260x320mm UV tray)
- 6 x ME26-28MC-1 (28 sample combs, 1mm thick)
- 1 x ME26-LG (Loading guides (Set))
- 1 x Black & red electrophoresis cable
- 1 x Flexi caster



All combs are multichannel pipette compatible



Loading guides allow easy well identification and sample loading

Specification

Cat. No.	ME20-10-20	ME20-25	ME26-16-24-32
Dimension (WxLxH)	15.6"x9.1"x3.5" (395x230x90mm)		19.7"x11"x3.5" (500x280x90mm)
Gel Dimension (WxL)	7.9"x3.9" (200x100mm) 7.9"x7.9" (200x200mm) 7.9"x9.8" (200x250mm)(Optional)	7.9"x9.8" (200x250mm)	10.2"x6.3" (260x160mm) 10.2"x9.5" (260x240mm) 10.2"x12.6" (260x320mm)
Maximum Sample	200 for 7.9"x3.9" (200x100mm) Tray (4x50 sample combs) 450 for 7.9"x7.9" (200x200mm) Tray (9x50 sample combs)	550 for 7.9"x9.8" (200x250mm) Tray (11x50 sample combs)	336 for 10.2"x6.3" (260x160mm) Tray (6x56 sample combs) 504 for 10.2"x9.5" (260x240mm) Tray (9x56 sample combs) 672 for 10.2"x12.6" (260x320mm) Tray (12x56 sample combs)
Buffer Volume	0.32gal (1200ml)		0.37gal (1400ml)
Construction	Injection molded construction		N /A
	Durable, leak proof environment for complete safety and long life		N /A
Cassette Type Electrode	Inexpensive, easy to replace		
	Made of 99.99% corrosion resistant pure platinum		
Electrical Safety	Lid can only be fastened in one way		
	Upon lid removal, power is disconnected from buffer chamber		
Rapid Casting Gel	Use casting dams		Use flexible caster

Ordering Information

Cat. No.	Product Description	Cat. No.	Product Description
ME20-10-20	Maxi, 200x100 & 200x200mm UV tray, 2x20 sample combs	ME26-16-24-32	Maxi-plus 260x160mm, 260x240mm, 260x320mm UV tray, 6x28 sample combs
ME20-25	Maxi, 200x250mm UV tray, 2x20 sample combs	ME26-UV16	Maxi plus, 260x160mm UV tray
ME20-UV10	Maxi, 200x100mm UV tray	ME26-UV24	Maxi plus, 260x240mm UV tray
ME20-UV20	Maxi, 200x200mm UV tray	ME26-UV32	Maxi plus, 260x320mm UV tray
ME20-UV25	Maxi, 200x250mm UV tray	ME26-FC	Flexible caster for gels up to 320mm. Casts 70, 100, 150,160, 200, 240 and 320mm long gels
ME15/20-FC	Midi plus-2/Maxi, Flexicaster	ME26-UVS	260mm UV gel scoop
ME20-UVS	200mm UV gel scoop	ME26-LG	Loading Guides for Maxi-plus
ME20-UVDAM	Maxi, UV tray dams (2 pcs)	ME26LID	Maxi-plus lid (No cables)
ME20-LG	Loading Guides for Maxi	ME26TANK	Maxi-plus Tank (including electrodes)
ME20LID	Maxi lid (No cables)		
ME20TANK	Maxi Tank (including electrodes)		

Accessories

Cat. No	Comb Description	Sample Volume	Cat. No	Comb Description	Sample Volume
ME20-1-0.75	Prep 1, Marker 1, 0.75mm thick	506ul	ME20-16-1.5	16 sample, 1.5mm thick	61ul
ME20-2-0.75	Prep 2, Marker 2, 0.75mm thick	236ul	ME20-20MC-1.5	20 sample MC, 1.5mm thick	41ul
ME20-4-0.75	Prep 4, Marker 2, 0.75mm thick	115ul	ME20-25-1.5	25 sample, 1.5mm thick	32ul
ME20-10-0.75	10 sample, 0.75mm thick	54ul	ME20-30-1.5	30 sample, 1.5mm thick	26ul
ME20-16-0.75	16 sample, 0.75mm thick	30ul	ME20-36-1.5	36 sample, 1.5mm thick	22ul
ME20-20MC-0.75	20 sample MC, 0.75mm thick	20ul	ME20-40MC-1.5	40 sample MC, 1.5mm thick	17ul
ME20-25-0.75	25 sample, 0.75mm thick	16ul	ME20-50-1.5	50 sample, 1.5mm thick	16ul
ME20-30-0.75	30 sample, 0.75mm thick	13ul			
ME20-36-0.75	36 sample, 0.75mm thick	11ul	ME20-1-2	Prep 1, Marker 1, 2mm thick	1350ul
ME20-40MC-0.75	40 sample MC, 0.75mm thick	8ul	ME20-2-2	Prep 2, Marker 2, 2mm thick	630ul
ME20-50-0.75	50 sample, 0.75mm thick	8ul	ME20-4-2	Prep 4, Marker 2, 2mm thick	306ul
			ME20-10-2	10 sample, 2mm thick	144ul
ME20-1-1	Prep 1, Marker 1, 1mm thick	675ul	ME20-16-2	16 sample, 2mm thick	81ul
ME20-2-1	Prep 2, Marker 2, 1mm thick	315ul	ME20-20MC-2	20 sample MC, 2mm thick	54ul
ME20-4-1	Prep 4, Marker 2, 1mm thick	153ul	ME20-25-2	25 sample, 2mm thick	42ul
ME20-10-1	10 sample, 1mm thick	72ul	ME20-30-2	30 sample, 2mm thick	34ul
ME20-16-1	16 sample, 1mm thick	41ul	ME20-36-2	36 sample, 2mm thick	29ul
ME20-20MC-1	20 sample MC, 1mm thick	27ul	ME20-40MC-2	40 sample MC, 2mm thick	23ul
ME20-25-1	25 sample, 1mm thick	21ul	ME20-50-2	50 sample, 2mm thick	21ul
ME20-30-1	30 sample, 1mm thick	17ul			
ME20-36-1	36 sample, 1mm thick	14ul	ME26-28MC-0.75	28 sample MC, 0.75mm thick	25ul
ME20-40MC-1	40 sample MC, 1mm thick	11ul	ME26-56MC-0.75	56 sample MC, 0.75mm thick	10ul
ME20-50-1	50 sample, 1mm thick	10ul	ME26-28MC-1	28 sample MC, 1mm thick	34ul
			ME26-56MC-1	56 sample MC, 1mm thick	14ul
ME20-1-1.5	Prep 1, Marker 1, 1.5mm thick	1013ul	ME26-28MC-1.5	28 sample MC, 1.5mm thick	51ul
ME20-2-1.5	Prep 2, Marker 2, 1.5mm thick	473ul	ME26-56MC-1.5	56 sample MC, 1.5mm thick	20ul
ME20-4-1.5	Prep 4, Marker 2, 1.5mm thick	230ul	ME26-28MC-2	28 sample MC, 2mm thick	68ul
ME20-10-1.5	10 sample, 1.5mm thick	108ul	ME26-56MC-2	56 sample MC, 2mm thick	27ul

* All images are for reference only, actual products might differ from the pictures above.
* Technical specifications subject to change without notice.

Mini Vertical Gel Electrophoresis Apparatus

MV-10DSYS

Mini Vertical is an injection molded vertical electrophoresis system providing a leak-proof environment and safe operation. Its vertical tank is designed for blotting compatibility. The dual 100x100mm plate is the most popular application and it is capable of handling up to 4 plates. In addition, packages with Mini 300V Power supply is ideally offered to individuals in the laboratory at a competitive and acceptable pricing to avoid time waiting for basic instruments and to accelerate experimental progress. Simple rapid and leak-proof gel casting.



MV-10DSYS

This product is offered as a complete system for the user to cast, and run electrophoresis. including:

- 1 x Electrophoresis tank & lid & inner running module
- 1 x MV-10NG (100x100mm notched glass plates, 2mm thick, pk/2)
- 1 x MV-10PGS1 (100x100mm plain glass plates with 1mm bonded spacers, pk/2)
- 1 x MV-10DP (dummy plate)
- 2 x MV-10-12-1 (12 sample combs, 1mm thick)
- 1 x MV-10DCAST (100x100mm casting base)
- 1 x MV 10ICB (mini cooling pack)
- 1 x Black & red electrophoresis cable



1
Insert glass plates and slide gates to create efficient seal.



2
Transfer to casting base and tighten cams.



3
It is best to turn the cams in opposite directions to each other.



4
Pour gel solution, insert combs and allow gel to polymerize.

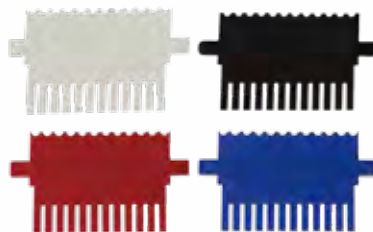

Extensive range of combs
Black: 0.75mm for ultra resolved bands
White: 1mm supplied as standard
Red: 1.5mm for large sample volume
Blue: 2mm for large sample volume



5
Transfer to tank, fill with buffer and run.



MC = Multi-channel pipette compatible

Running 4 gels
simultaneously



* If your want to run 4 gels, a set of notched glass plate and also bonded spacer would be required to buy separately.

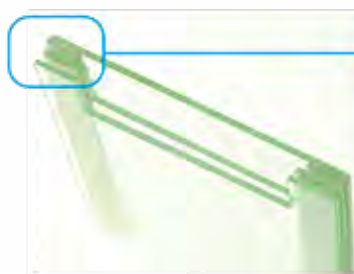

MV-10DSYS

is capable to run up to 4 gels when using a triple glass plate sandwich.



MV10-Mini300

Features

- Low buffer consumption
- Single molded tank
- Up to 4 gels run at one time
- Great indications for gel making and running
- Ice cooling pack
- Easy gel casting and no gel leakage
- Competitive pricing
- Compatible with all precast gels (100x100mm or 100x80mm)

Specification

Cat. No.	MV-10DSYS
Dimension (WxLxH)	Approx. 7.5"x5.1"x5.9" (190x130x150mm)
Plate Dimension (WxL)	Approx. 3.9" 3.9" (100x100mm)
Gel Dimension (WxL)	Approx. 3.4"x3.2" (85x80mm)
Maximum Sample	80 samples, 20 samples per gel
Buffer Volume	0.07gal -0.32gal (250 -1200ml)
Ice Cooling Pack	Yes
Dummy Plate And Casting Base	Yes
Construction	Injection molded construction
	Durable, leak proof environment for complete safety and long life
Electrical Safety	Lid can be fastened in only one way
	Upon lid removal, power is disconnected from buffer chamber
Rapid Casting Gel	Use gel maker stand

Ordering Information

Cat. No.	Product Description
MV-10DSYS	Complete Mini Vertical Gel Electrophoresis Apparatus
	Mini 100x100mm Dual, 2 sets of glass plates with 1mm thick bonded spacers
	2x12 sample, 1mm thick combs, cooling pack, dummy plate and casting base
MV10EXCASTERSYS	External Casting System, upstand + base
MV10EXCASTER	External Casting Upstand - no casting base
MV-10DCAST	100x100mm casting base
MV-10DCASTM	Replacement Silicone Mat for 100x100mm casting base
MV-10LID	MV-10 lid (No cables)
MV-10TANK	MV-10 tank
MV-10ICB	Mini cooling pack
MV-10PG	100x100mm plain glass plates, 2mm thick (pk/2)
MV-10PGS0.75	100x100mm plain glass plates with 0.75mm bonded spacers (pk/2)
MV-10PGS1	100x100mm plain glass plates with 1mm bonded spacers (pk/2)
MV-10PGS1.5	100x100mm plain glass plates with 1.5mm bonded spacers (pk/2)
MV-10PGS2	100x100mm plain glass plates with 2mm bonded spacers (pk/2)
MV-10NG	100x100mm notched glass plates, 2mm thick (pk/2)
MV-10NGS0.75	100x100mm notched glass plates with 0.75mm bonded spacers (pk/2)
MV-10NGS1	100x100mm notched glass plates with 1mm bonded spacers (pk/2)
MV-10NGS1.5	100x100mm notched glass plates with 1.5mm bonded spacers (pk/2)
MV-10NGS2	100x100mm notched glass plates with 2mm bonded spacers (pk/2)
MV-10DP	Dummy plate, 100x100mm
MV-10S0.75	100mm spacers - 0.75mm (pk/2)
MV-10S1	100mm spacers - 1mm (pk/2)
MV-10S1.5	100mm spacers - 1.5mm (pk/2)
MV-10S2	100mm spacers - 2mm (pk/2)



MV10EXCASTER

Accessories

MC = Multi-channel pipette compatible

SV = Sample volume for 5mm thick gel (ul)

Cat. No.	Product Description	SV
MV-10-1-0.75	Comb 1 Prep, 1 Marker, 0.75mm thick	500ul
MV-10-5-0.75	Comb 5 sample, 0.75mm thick	70ul
MV-10-8MC-0.75	Comb 8 sample MC, 0.75mm thick	40ul
MV-10-9-0.75	Comb 9 sample, 0.75mm thick	35ul
MV-10-10-0.75	Comb 10 sample, 0.75mm thick	30ul
MV-10-12-0.75	Comb 12 sample MC, 0.75mm thick	25ul
MV-10-16MC-0.75	Comb 16 sample MC, 0.75mm thick	20ul
MV-10-20-0.75	Comb 20 sample, 0.75mm thick	15ul
MV-10-1-1	Comb 1 Prep, 1 Marker, 1mm thick	650ul
MV-10-5-1	Comb 5 sample, 1mm thick	100ul
MV-10-8MC-1	Comb 8 sample MC, 1mm thick	60ul
MV-10-9-1	Comb 9 sample, 1mm thick	50ul
MV-10-10-1	Comb 10 sample, 1mm thick	40ul
MV-10-12-1	Comb 12 sample, 1mm thick	35ul
MV-10-16MC-1	Comb 16 sample MC, 1mm thick	25ul
MV-10-20-1	Comb 20 sample, 1mm thick	20ul

Cat. No.	Product Description	SV
MV-10-1-1.5	Comb 1 Prep, 1 Marker, 1.5mm thick	1000ul
MV-10-5-1.5	Comb 5 sample, 1.5mm thick	140ul
MV-10-8MC-1.5	Comb 8 sample MC, 1.5mm thick	80ul
MV-10-9-1.5	Comb 9 sample, 1.5mm thick	70ul
MV-10-10-1.5	Comb 10 sample, 1.5mm thick	30ul
MV-10-12-1.5	Comb 12 sample MC, 1.5mm thick	50ul
MV-10-16MC-1.5	Comb 16 sample MC, 1.5mm thick	40ul
MV-10-20-1.5	Comb 20 sample, 1.5mm thick	30ul
MV-10-1-2	Comb 1 Prep, 1 Marker, 2mm thick	1300ul
MV-10-5-2	Comb 5 sample, 2mm thick	200ul
MV-10-8MC-2	Comb 8 sample MC, 2mm thick	120ul
MV-10-9-2	Comb 9 sample, 2mm thick	100ul
MV-10-10-2	Comb 10 sample, 2mm thick	80ul
MV-10-12-2	Comb 12 sample, 2mm thick	70ul
MV-10-16MC-2	Comb 16 sample MC, 2mm thick	50ul
MV-10-20-2	Comb 20 sample, 2mm thick	40ul

* All images are for reference only, actual products might differ from the pictures above.
* Technical specifications subject to change without notice.

Complete Mini Electro Blot System

Complete Mini Sub Blot System

MEBM10 / MSB10
MV-10CBS

Electro Blot Systems are primarily designed for wet electrophoresis of proteins, and offer a combination of increased capacity with economical features. Electro Blot Systems have increased capacity over standard systems. Up to five gel blot cassettes may be utilized at any time for Electro Blot Mini. This is especially useful in high throughput laboratories. A uniform electric field is provided by a high intensity coiled electrode and ensures uniform transfer across the blot surface. The cassette's open architecture that ensures the maximum blot area allows direct transfer of current. Its rigid construction that ensures contact between the gel and membrane is retained throughout the blot and an even pressure is maintained. These units are compatible with magnetic stirrers to aid heat dispersal and prevent pH drifts in the buffer due to incomplete buffer mixing. Each unit includes a cooling pack to further enhance transfer efficiency by removing excess heat. This also saves buffer for added economy.

The Complete Electrophoresis Systems include both modules for gel electrophoresis, electroblotting and accessories, to provide a complete Mini gel casting, running and electroblotting system. The electroblotting module includes four inter-locking cassettes and sixteen fiber pads. A high intensity current is generated by coiled platinum electrodes. These features, in conjunction with the advanced cooling system allow for rapid electroblotting in as little as one hour.

For MEBM series Features

- Ideal for wet electroblotting of proteins – Western Blotting
- Hinged cassettes for added convenience
- Accommodates gel thickness from 0.25 to 3mm

For MV-CBS series Features

- Versatile: Interchangeable modules for slab gel and Electroblotting using a single universal buffer tank
- Hinged cassettes
- High intensity electrodes
- blot capacity
- Rapid set-up cooling

Mini Electro Blot System

CE



MEBM10

Complete Mini Electro & Blot System

CE

MV-10CBS

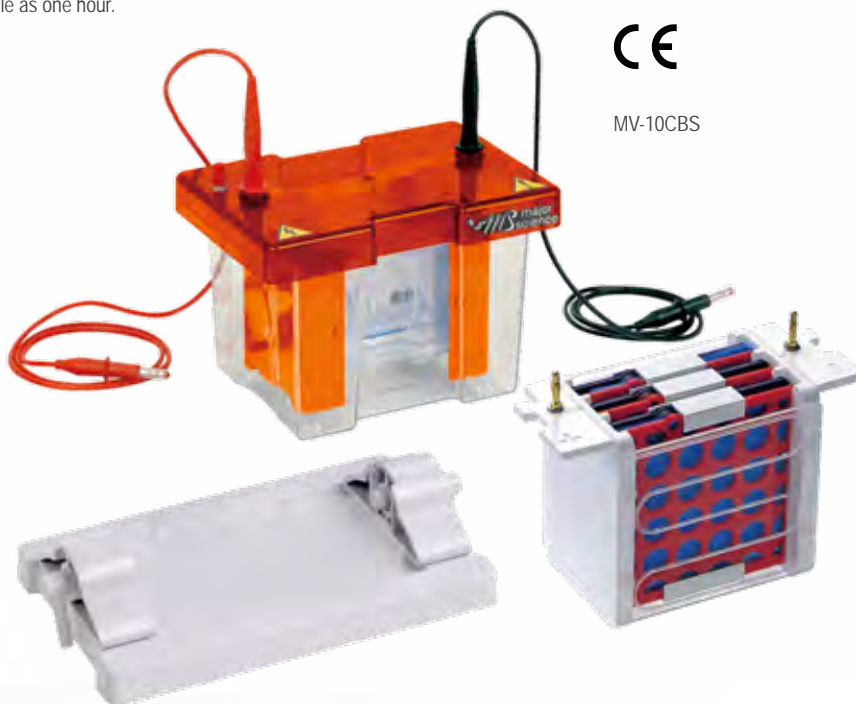

Specification

Cat. No.	MEBM10
Dimension (WxLxH)	7.5"x5.1"x7.5" (190x130x190mm)
Gel Dimension (WxL)	3.9"x3.9" (100x100mm)
Maximum Sample	5 Blots, 100x100mm
Accomodate Gel Thickness	0.25 - 3mm
Buffer Volume	1000 - 1500ml
Ice Cooling Pack	Yes
Construction	Durable, leak proof environment for complete safety and long life
Electrical Safety	Lid can only be fastened in one way
	On removal, power is disconnected from buffer chamber
Cassette Type	Hinged cassette

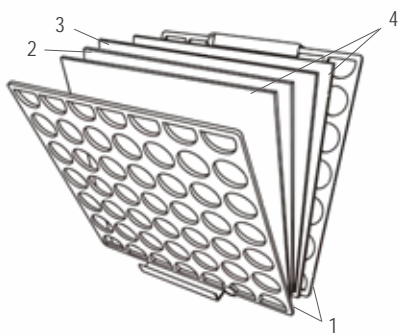

1. Cassette Ends
2. Gel
3. Membrane
4. Blue Foam Pads & Papers

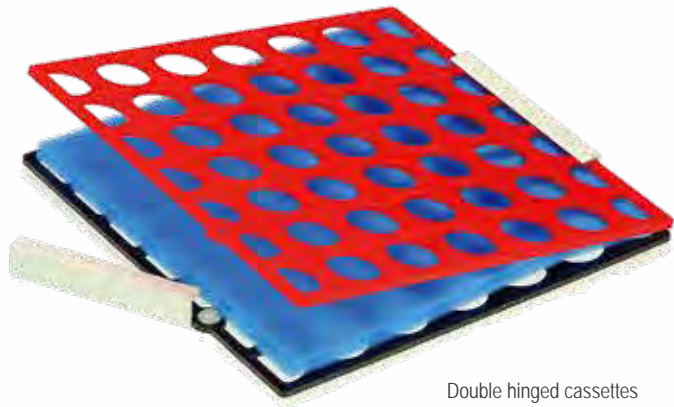

Double hinged cassettes
for added convenience

Ordering Information

Cat. No.	Product Description
MEBM10	Electro Blot Mini, 100x100mm system for 5 cassettes, including 1 x tank and 1 x lid, 5 x cassettes, cooling pack and 16 extra fiber pads
MSB10	Sub Blot Mini, 100x100mm system for 4 cassettes, including 1 x tank and 1 x lid, 4 x cassettes, cooling pack and 16 extra fiber pads
MSB10C	Blot Mini cassette
MSB10F	Fiber pads for Blot Mini - pack of 6
MV10BI	Blot Mini Insert - including 4 cassettes and 16 fibre pads

MV-10CBS	Complete system for Mini Vertical Electrophoresis & Blotting, comprising:
	1x Mini Vertical unit, including:
	2x2mm thick notched glass plates
	2x2mm thick plain plates with 1mm thick bounded spacers, 1 x dummy plate
	2 x combs(1mm thick,12 samples), 1 x casting base, silicone mat, cooling pack
	1 x Electroblotting module, including:
1 x Internal electroblotting module	
4 x Compression cassette for gel size up to 100x100mm, 16 x fiber pads	

Semi Dry Mini / Semi Dry Midi

MSD series

Semi Dry Mini offers rapid transfer times for DNA, RNA and protein blotting, typically 15 to 30 minutes. It can be used for all types of blotting, including Western, Southern and Northern blots. It features an uncomplicated buffer and set up procedure and is compatible with gel thickness from 0.25 up to 10mm. The unit is compatible with its respective vertical electrophoresis system. It only requires very low buffer volume, typically only a few milliliters of buffer per transfer. A screw down lid secures the blot sandwich and allows complete control of pressure ensuring even transfer. The electrodes, comprising of a platinum coated anode and stainless steel cathode, will exhibit practically no corrosion and provides many years of trouble free use. Uniform heat dispersion across the blot sandwich ensures stable transfer times and prevents heat induced sample loss or transfer distortions. It also allows viewing of the blot sandwich to ensure correct positioning and transfer is occurring correctly. Electrode plates are fully separated to prevent arcing or damage.

Features

- Low buffer consumption
- Rapid transfer time
- Western, Southern and Northern blots
- Screw down lid – Gels from 0.25 up to 10mm thick
- Uniform heat dispersion
- Long life electrodes



Semi Dry Mini and Semi Dry Midi

Specification

Cat. No.	MSD10	MSD20
Dimension (WxLxH)	Approx. 6.3"x6.3"x2.8" (160x160x70mm)	Approx. 10.2"x10.2"x2.8" (260x260x70mm)
Gel Dimension (WxL)	Approx. 3.9"x3.9" (100x100mm)	Approx. 7.9"x7.9" (200x200mm)
Maximum Sample	1 Blot, 80x85mm	1 Blot, 160x175mm 2 Blots, 160x85mm 4 Blots, 80x85mm
Buffer Volume	5ml	20ml
Accomodate Gel Thickness	0.25-10mm	
Economic Transfer	Yes	
Construction	Durable, leak proof environment for complete safety and long life	

Ordering Information

Cat. No.	Product Description
MSD10	Semi Dry Mini, 100x100mm System
MSD20	Semi Dry Midi, 200x200mm System



Taiwan Headquarters

Headquarters:

No. 156, Sec. 1, Guoji Rd., Taoyuan Dist.,
Taoyuan City 33061, Taiwan
T/+886-3-3762878
F/+886-3-3761310

Factory:

No.19, Ln. 207, Huakang St. Bade Dist.,
Taoyuan City 33464 Taiwan
T/ +886-3-3623319
F/ +886-3-3623133
Email : info@majorsci.com

Shanghai Office

Room 612, International business exhibition center,
9300 Hunan Road, Pudong, Shanghai, China
National toll-free No.:400-823-9177
T/ +86-21-50795277
F/ +86-21-50795277

US Office

19959 Sea Gull Way
Saratoga, CA 95070
U.S.A.
T/ +1-408-366-9866
F/ +1-408-446-1107

India Office

D. No. 12-13-99, Satguru Apts. Extn.
Street. No. 3, Lane No.1, Tamaka
Secunderabad – 500 017. India
T/ +91-40-27001515
T/ +91-40-27001586



www.majorsci.com

info@majorsci.com

